

# CL Challenger Lifts



**NEW**

**Designed Specifically  
for Heavy-Duty Cargo  
Carrying Vehicles**



**Model#: 15000-3S**

Heavy-Duty Cargo Vehicle 2-Post Lift  
15,000 lb. capacity

## 15000-3S series

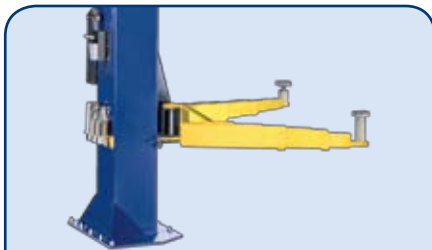

**15000-3S:**  
**Features Lower Profile Arm Design**  
3-stage front arms plus 3-stage rear arms

Challenger's new 15,000 lb. capacity heavy-duty cargo vehicle 2-post lift comes standard with 3-stage front and 3-stage rear arms. This new heavy-duty 2-post lift safely and properly reaches and accommodates any cargo van or transportation van/bus with step sides or lower profile ground effects.

Lift model 15000-3S and 15002-3S comes complete with all necessary adapters to lift vehicles and has optional adapters specific for certain cargo carrying vans. The standard pad adapters are 16% lower on our 15000-3S series than that of our traditional 15,000 lb. capacity 2-post.

## Features & Benefits:

- NEW**  
 3-stage front and 3-stage rear arms gives extended reach and retraction making it easier to lift a wider variety of cargo carrying vans.
- Lower profile**  
 Standard pad adapter is 16% lower than the standard 15,000 lb capacity 2-post lift to accommodate lower profile cargo vans.
- Ease of operation**  
 Single point air actuated lock release allows technician to disengage locks in both columns simultaneously.
- Stronger and more durable designed**  
 Oversized steel pulley reduces stress on equalization system and provides increased durability.
- Greater load spread**  
 60" lifting carriage helps to provide a more equal spread of weight which can prevent premature column wear.
- Safety engineered**  
 Padded overhead shut off system prevents vehicle damage should a vehicle come in contact with the overhead shutoff bar.

## Optional Accessories



### Part#: B10264

**Air and Electric workstation** Increase productivity with air supply and electric outlets on the lift column.

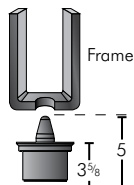

**Pin Adapter**  
Tightly fits into hole on frame

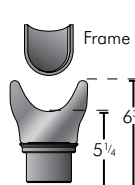

**Cradle Adapter**  
Frame rests snug in concave adapter

**Part #10333** comes standard with 2 pin adapters and 2 cradle adapters

Model Number	15000-3S	15002-3S
Lifting Capacity	15,000 lb. (6804kg)	
<b>A</b> Column Height	174" (4420mm)	198" (5029mm)
<b>B</b> Floor to Overhead Switch	167" (4242mm)	191" (4851mm)
<b>C</b> Rise Height <sup>1</sup>	82 1/4" (2089mm)	
<b>D</b> Screw Pad Height	5 1/4" - 13 1/4" (133 - 337 mm)	
<b>E</b> Inside of Columns	120" (3048mm)	
<b>F</b> Overall Width	154 3/4" (3931mm)	
<b>G</b> Arm Extension	75" (1905mm)	
<b>H</b> Arm Retraction	36 5/8" (930 mm)	
Drive Thru Clearance	106 3/4" (2711 mm)	
Ceiling Height Required	175" (4445 mm)	199" (5055mm)
Speed of Rise	80 Seconds	
Air Supply Required	85 - 115 psi	
Motor	2HP	
Voltage (1 Phase)	208v - 230v	

<sup>1</sup> Rise height is measured with high extension.

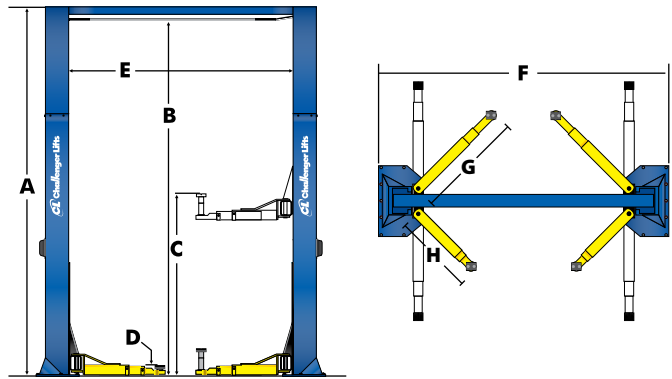

## Standard\*

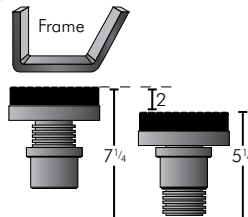

16% lower than the standard 15,000 lb. capacity 2-post lift to accommodate lower profile cargo vans.

**Pad Adapter**  
Frame rests on non-skid rubber telescoping screw pad

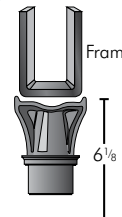

**Truck Adapter**  
**REQUIRED** when lifting vehicles with frame construction

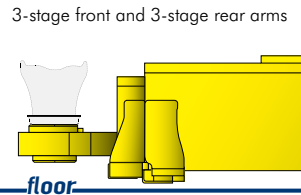

**floor**



**Stack Adapter Kit**  
Includes four 3" Extensions, two 6" Extensions & two Organizer Racks

\* Standard Adapters are not compatible with lift model #15000 (15,000 lb capacity) 2-post lift with 2-stage arms

For more information, contact your Authorized Challenger Lifts Distributor:



The Automotive Lift Institute (ALI) certifies the 15000-3S and 15002-3S described herein complies with the applicable provisions of the American National Standards ANSI/ALI ALCTV 2006 and is Third Party Validated by the ETL Testing Laboratory.

**CHALLENGER LIFTS, INC.**  
200 Cabel Street  
Louisville, Kentucky 40206

Phone Toll-Free: 800-648-5438  
502-625-0700  
Fax: 502-625-0711  
E-mail: sales@challengerylifts.com

Challenger Lifts, Inc. reserves the right to make changes to specifications without notice and without making changes retroactive. Unloading, installation and oil not included.